

PRODUCT NO.
10005639-XXXX

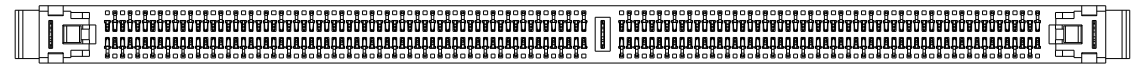
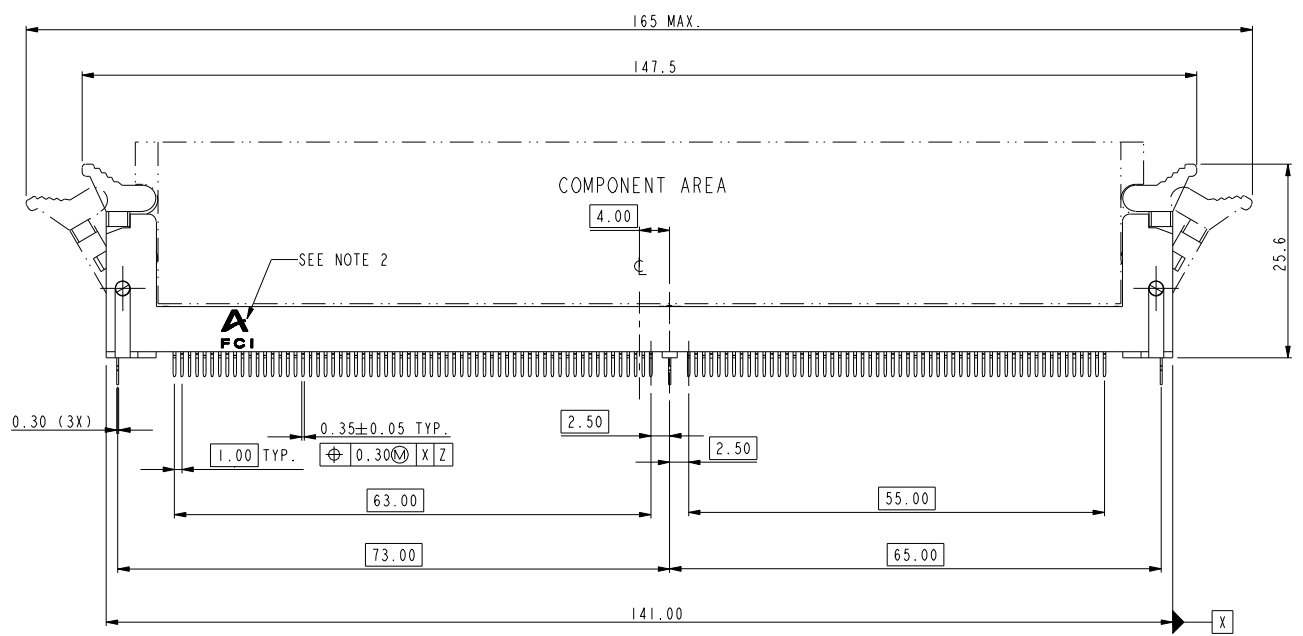
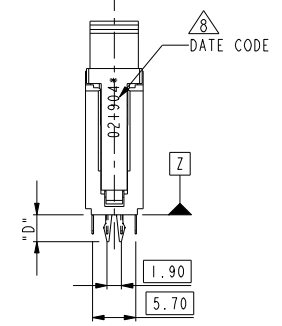
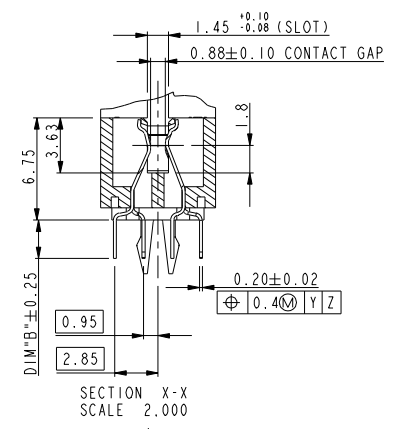
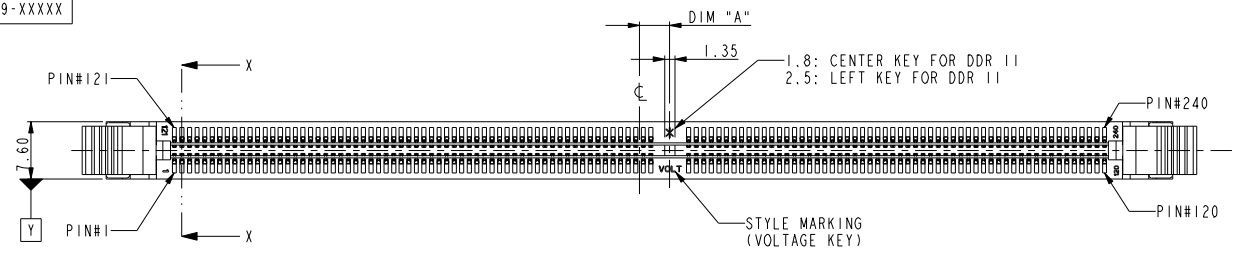

PART NO.	DIM "A"	DESCRIPTION
10005639-1****	4.00	1.8V
10005639-2****	3.00	2.5V
10005639-3****	5.00	X.XV

rev	ecn no	dr	date
V	DG06-0328	CS	09/08/06
W	DG07-0365	CS	06/09/07

www.fciconnect.com			surface <input checked="" type="checkbox"/>	tolerance std	projection	MM
			TOLERANCES UNLESS OTHERWISE SPECIFIED			
Dr	CHARLIE S	03/21/02	ANGULAR	0.X ± .38	size A4	Scale 0.500
Eng	CHARLIE S	03/21/02	LINEAR	0.XX ± .25		
Chr	GARY HSIEH	03/21/02	0° ± 2°	0.XXX ± .13	ECN T03-0057	
Appr	JOSEPH HSIA	03/21/02	Product family		Spec ref *	
			title DDR11 240P V/T METAL CLIP ASS'Y		dwg no 10005639	
			catalog		Rev. W	

Copyright FCI.

Copyright FCI.

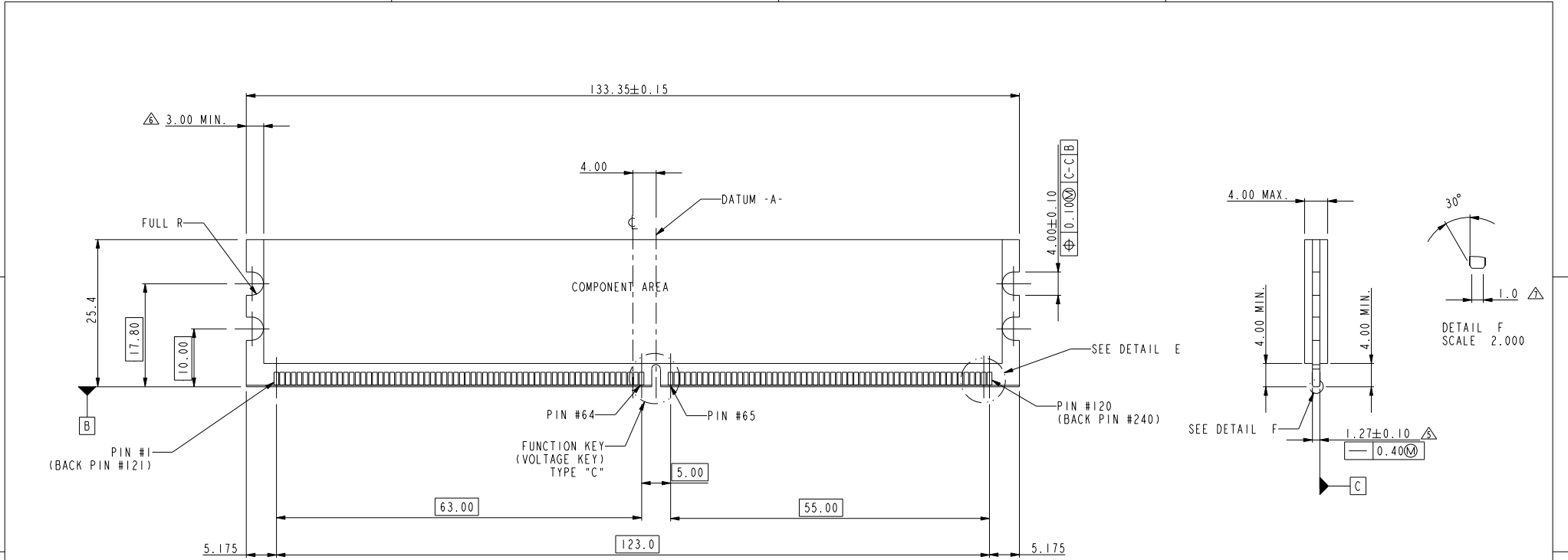

REFERENCE ONLY-SEE JEDEC SPEC MO-237 FOR DETAIL

SCALE 1.000

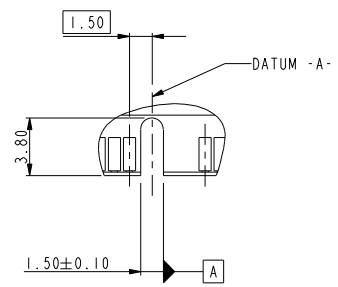

KEY POSITION #1
TYPE "L"
SCALE 2.000

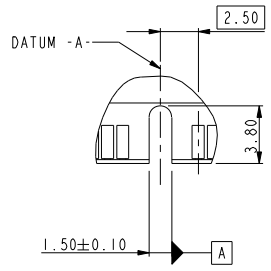

FUNCTION KEY
KEY POSITION #1
TYPE "C"
SCALE 2.000

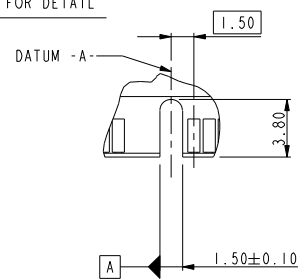

KEY POSITION #1
TYPE "R"
SCALE 2.000

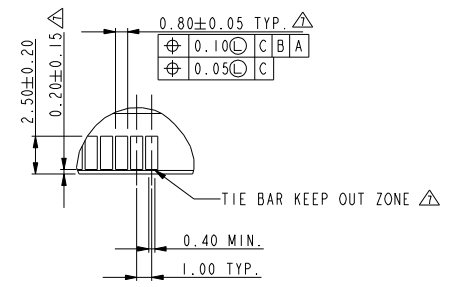

DETAIL E
SCALE 2.000

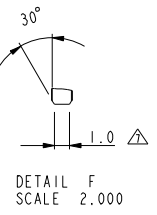

DETAIL F
SCALE 2.000

SUB KEY POS #1	DESCRIPTION
TYPE "R"	X.X VOLTAGE
TYPE "L"	2.5 VOLTAGE
TYPE "C"	1.8 VOLTAGE

tolerance unless otherwise specified	
linear	.X ± .38
	.XX ± .25
	.XXX ± .13
angles	0° ± 2°

	title DDRII 240P V/T METAL CLIP ASS'Y	dwg no 10005639	Rev. W
	catalog no PDM: Rev:W	STATUS: Released	sheet 2 of 4 Printed: Jun 03, 2008



Copyright FCI.

D

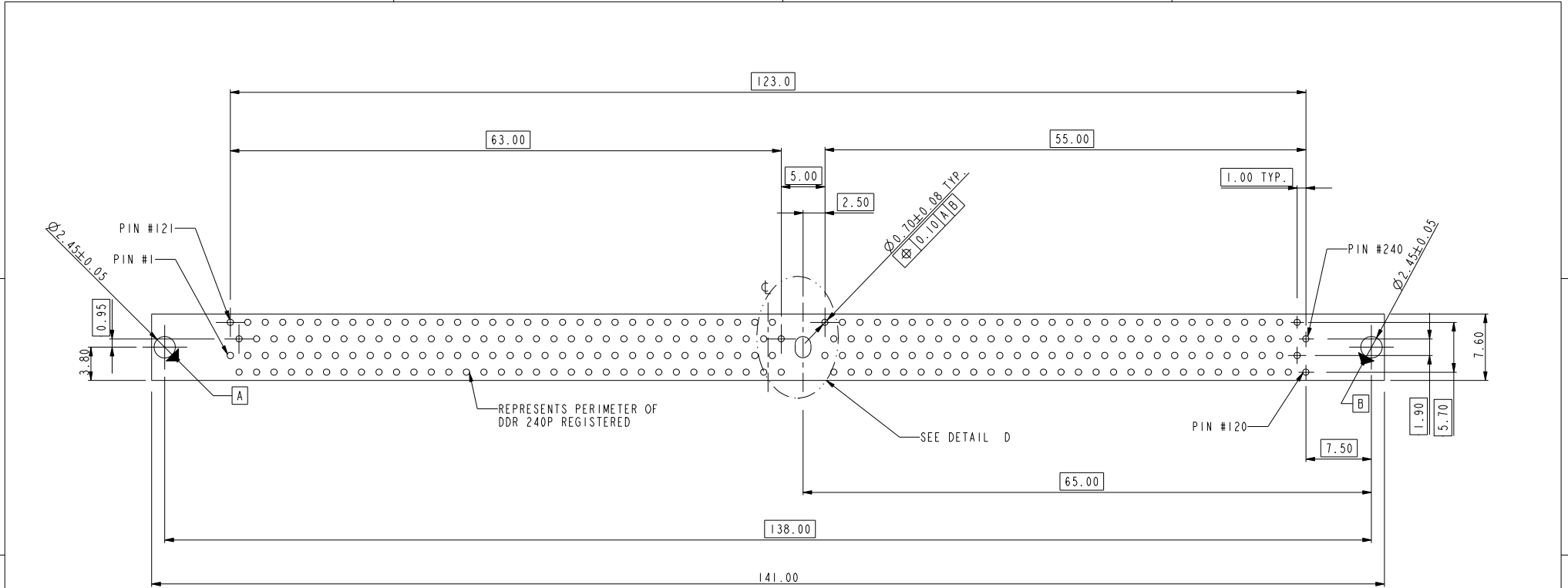

RECOMMENDED CIRCUIT BOARD HOLE LAYOUT

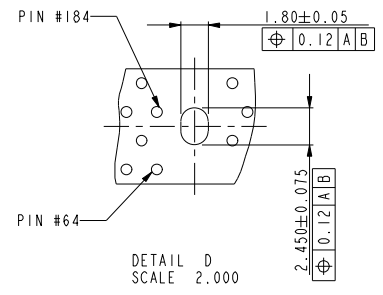

tolerance unless otherwise specified	
linear	.X ± .38
	.XX ± .25
	.XXX ± .13
angles	0° ± 2°

	title	DDR11 240P V/T METAL CLIP ASS'Y	dwg no	10005639	Rev.	W
	catalog	PDM: Rev:W	STATUS: Released	CUSTOMER	sheet 3 of 4	Printed: Jun 03, 2008

10005639 - □ □ □ □ □

STYLE : MECHANICAL KEYING

- 1 : 1.8 VOLT. W/ CENTER KEY#1
- 2 : 2.5 VOLT. W/ LEFT KEY#1
- 3 : X.X VOLT. W/ RIGHT KEY#1

METAL CLIP

- 1 : WITH METAL CLIP + DIM "D"=3.05
- 2 : WITH METAL CLIP + DIM "D"=3.56
- 3 : WITH METAL CLIP + DIM "D"=3.43

TAIL LENGTH

CODE	DIM "B"
0	2.54
1	2.67
2	3.18
3	4.00

PLATING

CODE	CONTACT	SOLDERTAIL	UNDERPLATE
1	10u" (0.25um) MIN. GOLD	100u" (2.54um) MIN. TIN/LEAD	50u" (1.27um) MIN. NICKEL OVERALL
2	15u" (0.38um) MIN. GOLD		
3	30u" (0.76um) MIN. GOLD		
4	3u" (0.076um) MIN. GOLD		
6LF	10u" (0.25um) MIN. GOLD	100u" (2.54um) MIN. 100% TIN	50u" (1.27um) MIN. NICKEL OVERALL
7LF	15u" (0.38um) MIN. GOLD		
8LF	30u" (0.76um) MIN. GOLD		
9LF	3u" (0.076um) MIN. GOLD		

COLOR OF HOUSING AND EJECTOR

- 0 : BLACK HOUSING + IVORY EJECTOR
- 1 : BLUE HOUSING + IVORY EJECTOR
- 2 : BLACK HOUSING + BLACK EJECTOR
- 3 : PURPLE HOUSING + IVORY EJECTOR
- 4 : ORANGE HOUSING + IVORY EJECTOR
- 5 : GREEN HOUSING + IVORY EJECTOR
- 6 : RED HOUSING + IVORY EJECTOR
- 7 : IVORY HOUSING + IVORY EJECTOR
- 8 : YELLOW HOUSING + IVORY EJECTOR
- 9 : IVORY HOUSING + BLACK EJECTOR

NOTES:

1. MATERIAL:
HOUSING: HIGH PERFORMANCE RESINS, GLASS FILLED UL94V-0 RATED.
EJECTOR: HIGH PERFORMANCE RESINS, GLASS FILLED UL94V-0 RATED.
TERMINAL: PHOSPHOR BRONZE.
METAL CLIP: COPPER ALLOY.
2. FCI LOGO TO BE APPROXIMATELY LOCATED AS SHOWN ON PRINT.
3. PRODUCT SPECIFICATION: GS-12-251.
4. PACKAGING SPECIFICATION: GS-14-899.
5. CARD THICKNESS APPLIES ACROSS TABS AND INCLUDES PLATING AND/OR METALIZATION.
6. 3.00 mm MINIMUM APPLIES TO BOTH 4.00 mm WIDE NOTCH LENGTH AND COMPONENT KEEPOUT AREA.
7. LEADING EDGE OF CONTACT PADS SPECIFIED BY THE KEEP OUT ZONE SHALL BE FREE OF BURRS AND EXTERNAL TIE BARS. FOR OPTIMUM PERFORMANCE, THE TIE BAR IS TO BE ON AN INTERNAL LAYER SO THAT THE REMNANT CANNOT CAUSE CONTACT DAMAGE.
8. THE DATE CODE IS SHOWN "MM-DD-YY*.". "*" MEANS PRODUCTION LINE CODE.
9. THIS PRODUCT MEETS EUROPEAN UNION DIRECTIVES AND OTHER COUNTRY REGULATIONS AS DESCRIBED IN GS-22-008.
10. THE HOUSING WILL WITH STAND EXPOSURE TO 260°C PEAK TEMPERATURE FOR 10 SECONDS IN A WAVE SOLDER APPLICATION.

tolerance unless otherwise specified	
linear	.X ± .38
	.XX ± .25
angles	.XXX ± .13
	0° ± 2°

	title	DDR11 240P V/T METAL CLIP ASS'Y	dwg no 10005639	Rev. W
	catalog no			

Copyright FCI.